

ARMCHAIR

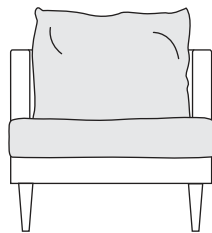

strona/page/Seite 1-2

F1 x2

no 154A



G1 x2

no 154B

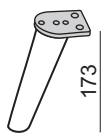

WSI M6x25

A x4



L-4

C x1

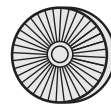

φ45x3

D x2



φ20x2

E x4

strona/page/Seite 2

H1 x2

no 150B

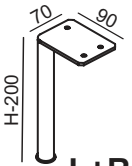

L+R

I1 x2

no 150C

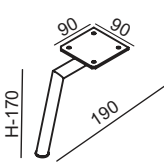

WS M6x25

K x14



φ20x2

M x4

1

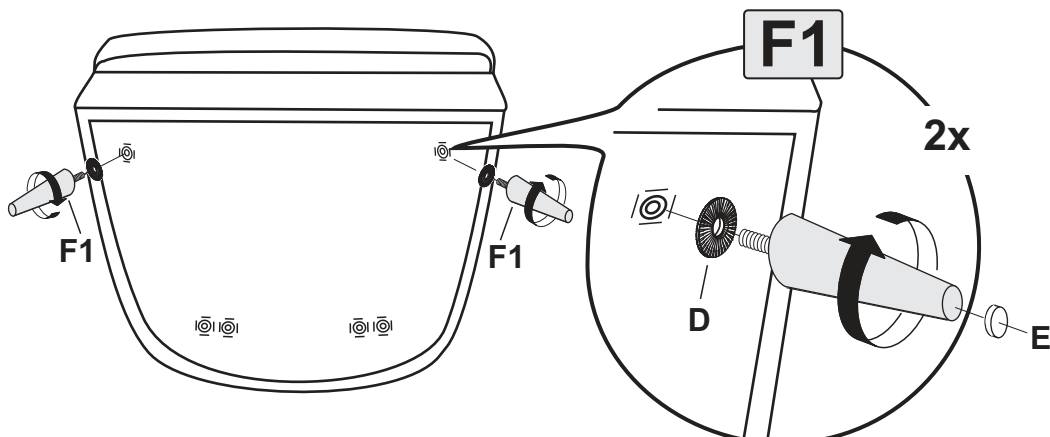

2

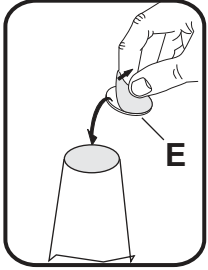
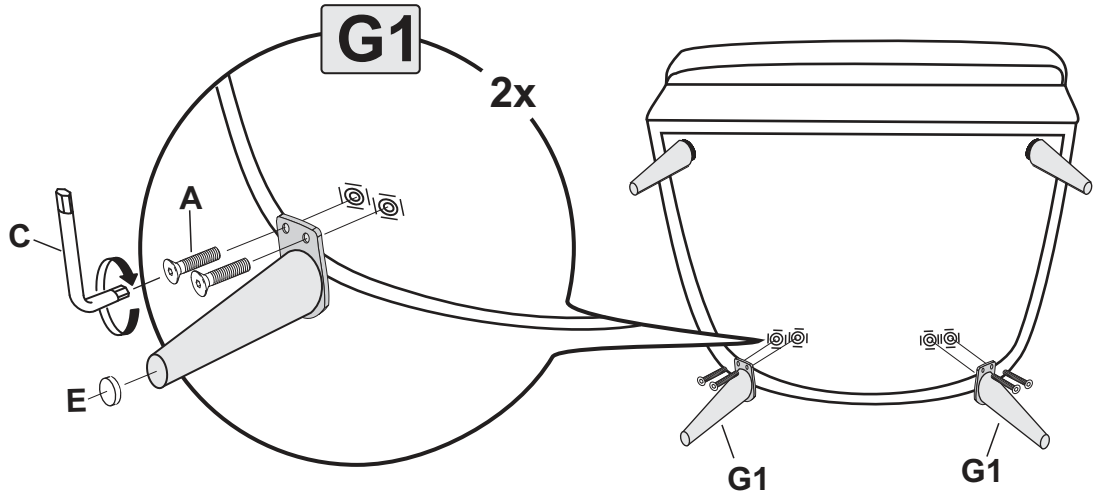

3

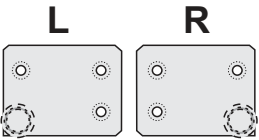
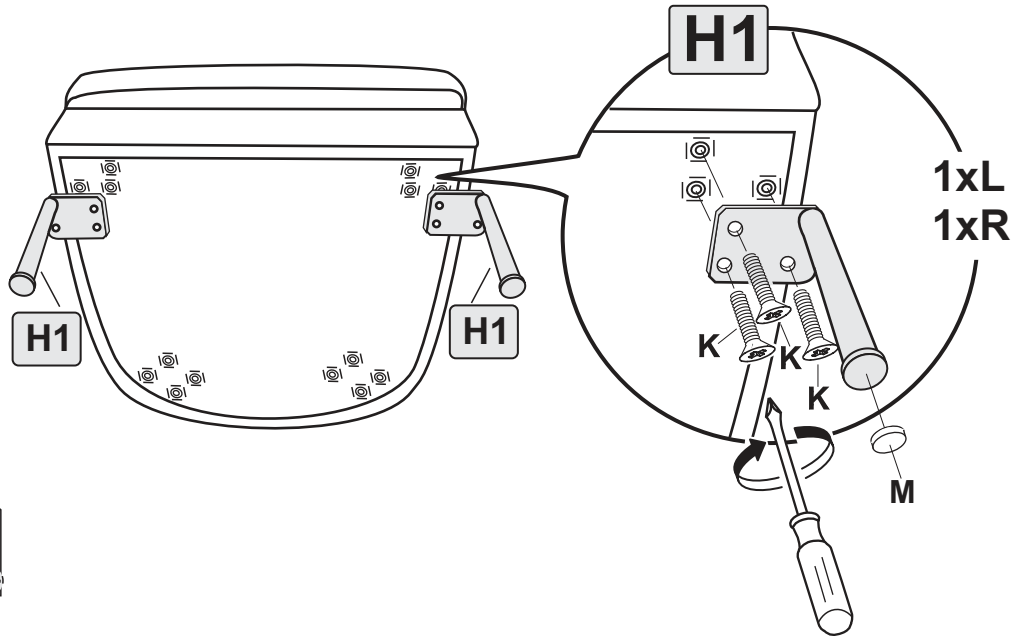

4

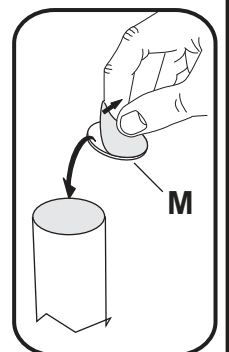
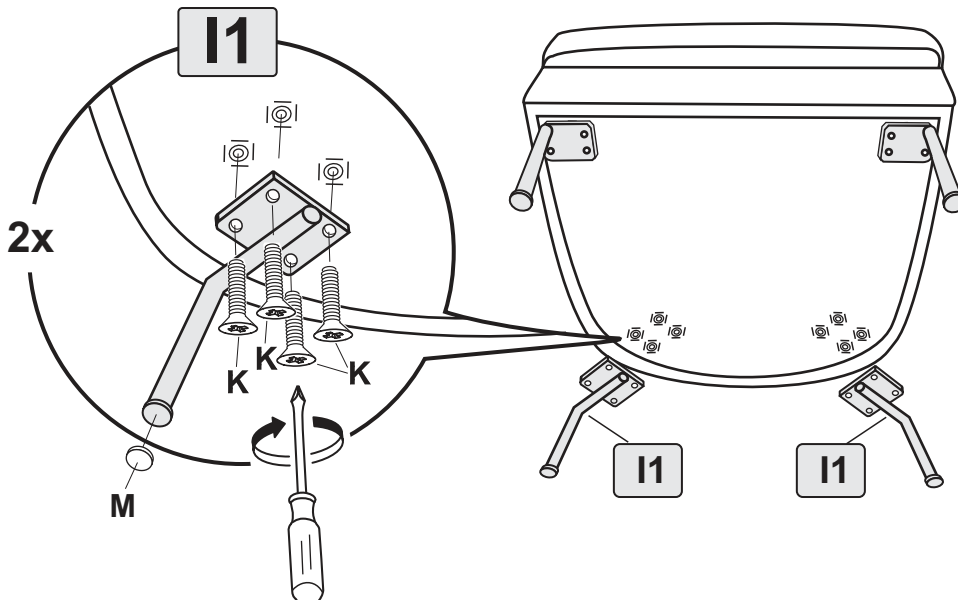

2

FOOTSTOOLS

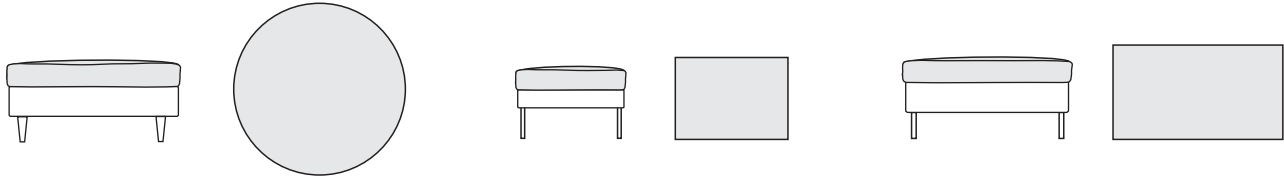

strona/page/seite 4

A1 x4

no 153

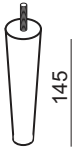

$\phi 45 \times 3$

D x4



$\phi 30 \times 2$

E x4

strona/page/seite 4

J1 x4

no 150D

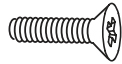
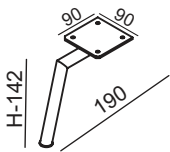

WS M6x25

K x16



$\phi 20 \times 2$

M x4

strona/page/seite 5

F1 x4

no 154A

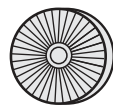
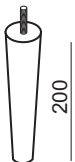

$\phi 45 \times 3$

D x4



$\phi 20 \times 2$

M x4

strona/page/seite 5

K1 x4

No 149

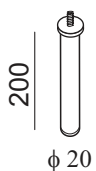

$\phi 20$

5

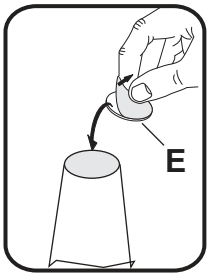
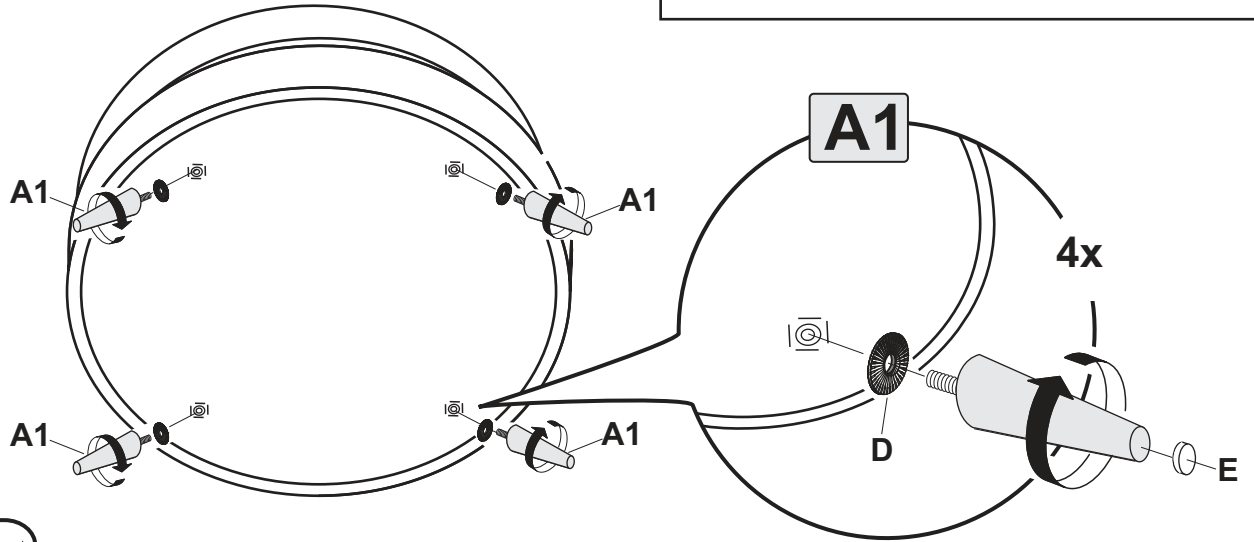
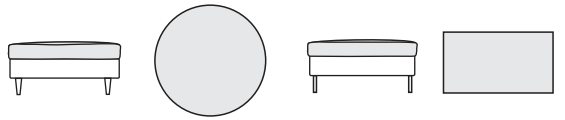

6

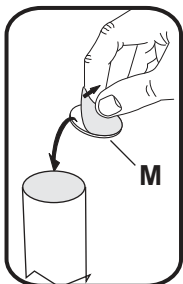
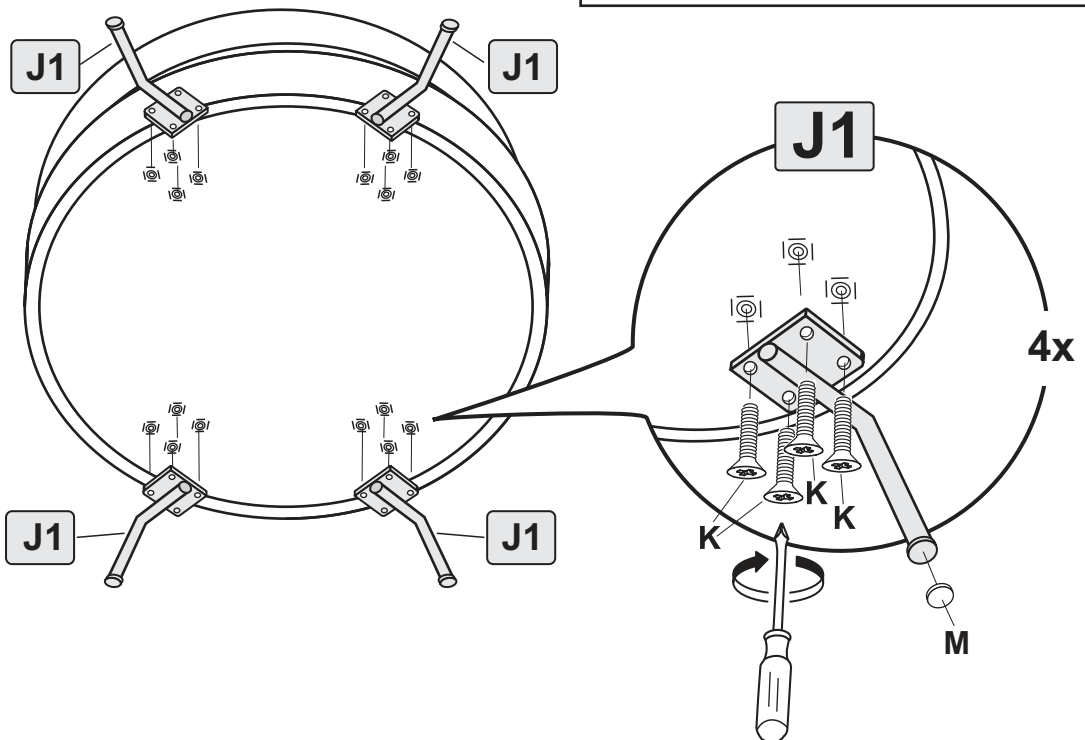
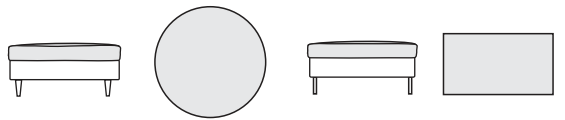

4

7

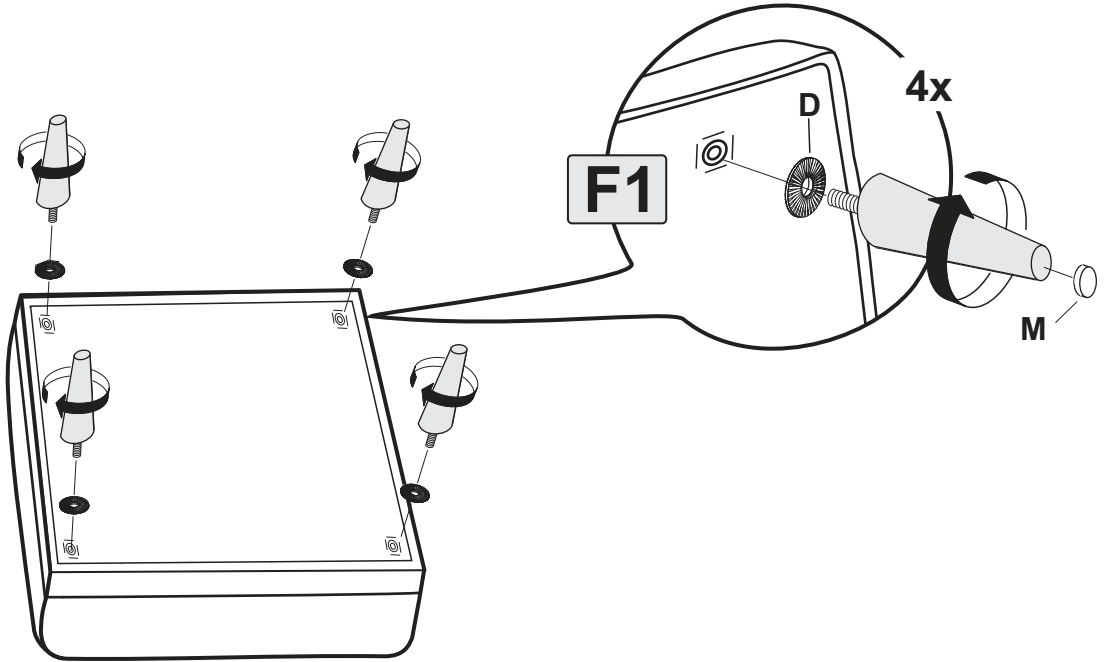
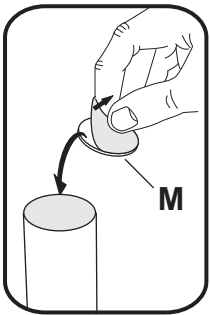

8

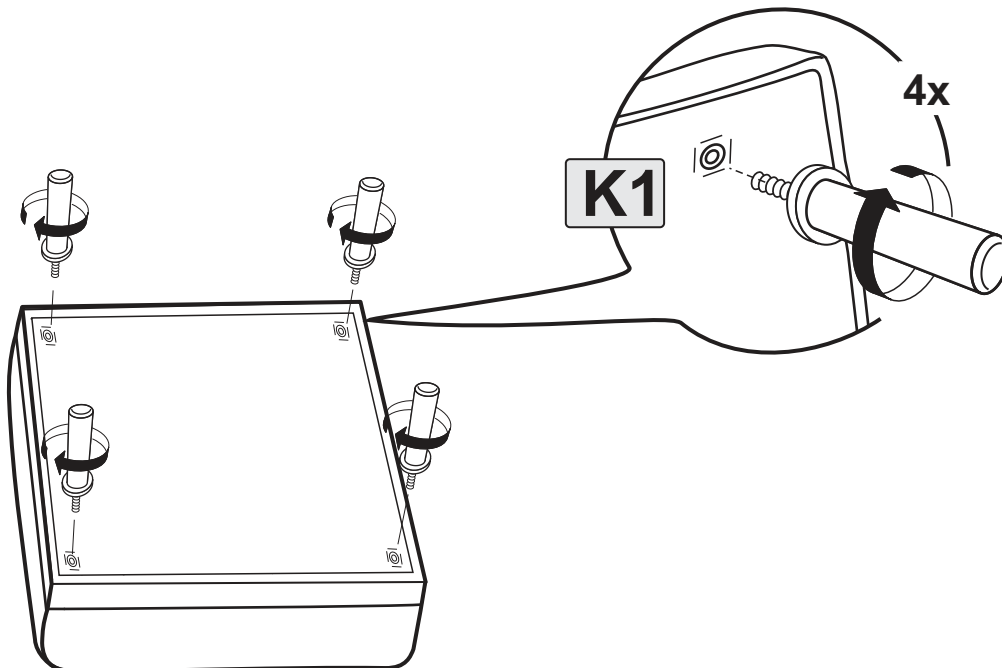
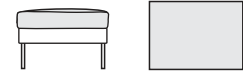

9

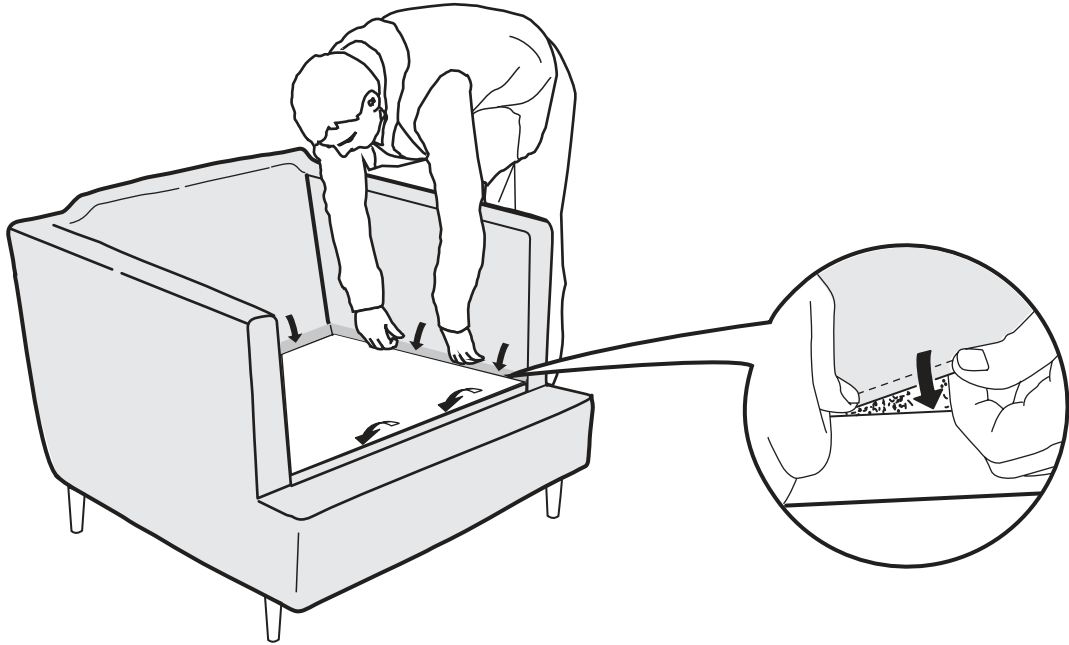

10

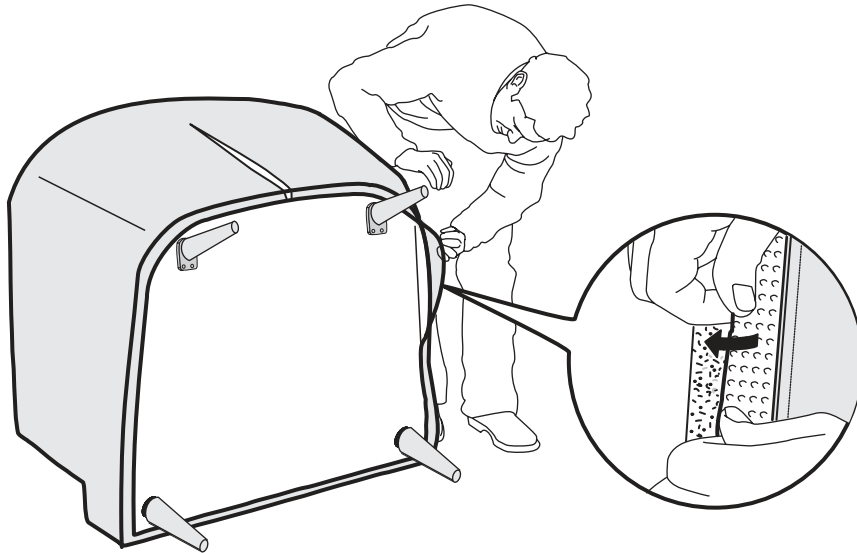

11

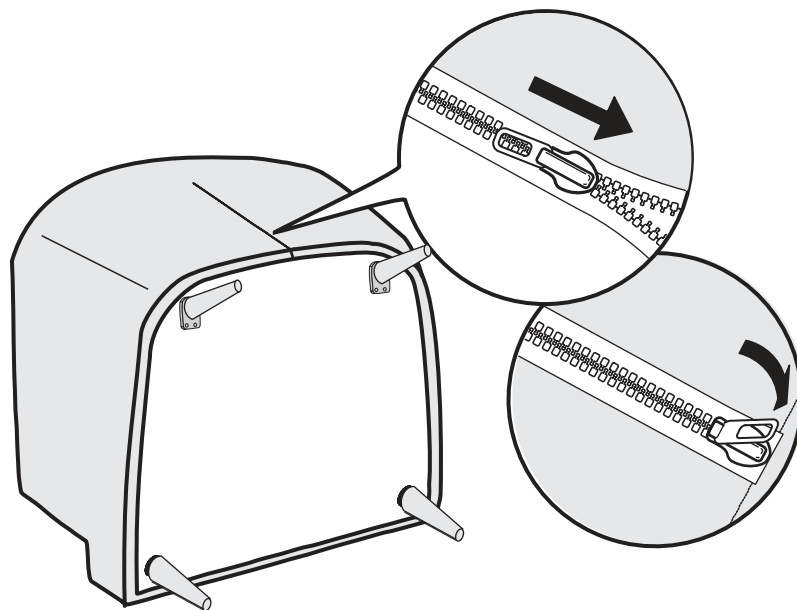

Zachowaj instrukcję / Please keep instructions / Bewahren Sie die Anleitung / Merci de garder l'instruction